

HillsTM Home Hub

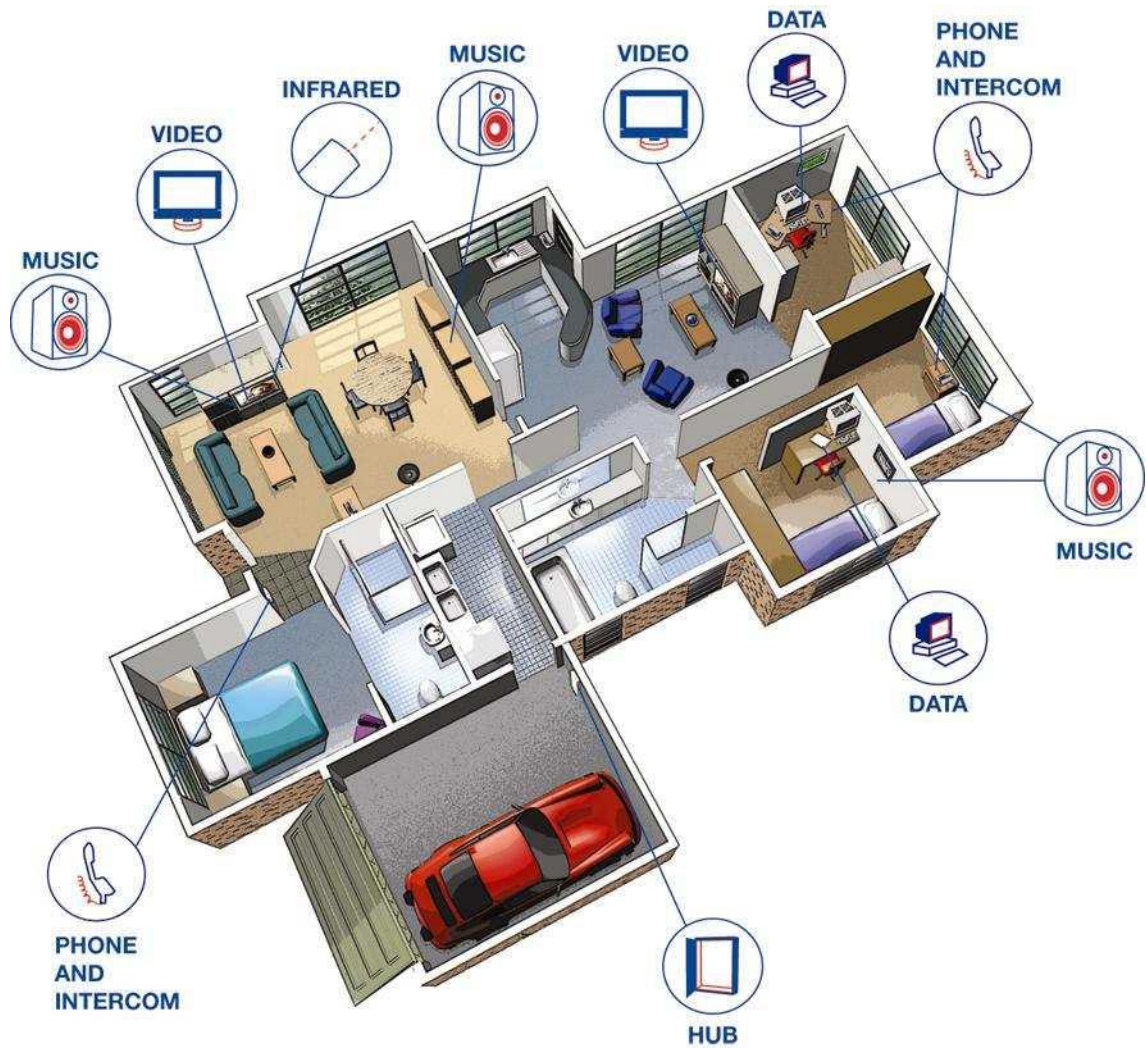

Owner's Manual

Hills Home Hub - "don't build a home without it"

Notice

Standards and regulations that govern the installation practices and requirements for these types of products include but may not be limited to the following listing:

For Australia & New Zealand installations:

- AS/NZS 3080: Telecommunications Installations - Integrated telecommunications cabling systems for commercial premises
- AS/NZS 3000: Electrical Installations - Buildings, Structures and Premises (SAA Wiring Rules)
- AS 3815: A guide to coaxial cabling in single and multiple premises
- AS/NZS 3086: Telecommunications Installations - Integrated telecommunications cabling systems for small office/home office premises
- ANSI/TIA/EIA-570-A: Residential Telecommunications Cabling Standard
- AS/NZS 3085: Telecommunications Installations - Administration of communications cabling systems
- AS2201: Intruder Alarm Systems

Additional requirements for Australia:

- ACA TS 008: Requirement for Authorised Cabling Products
- ACA TS 009: Installation Requirements for Customer Cabling (Wiring Rules)

Additional requirements for New Zealand:

- PTC 106:2005: Telecom Code of Practice for Residential type Generic Cabling Systems (see www.telepermit.co.nz/Ptc106.pdf)

All cabling must be installed to meet or exceed these standards. Penalties can apply for connecting non-compliant or non-approved equipment to a telecommunications network.

Please contact your installer if you have further enquiries regarding your specific Hills Home Hub and structured cabling installation. Service fees may apply.

Telepermit Notice for New Zealand

The grant of a Telepermit for any item of terminal equipment indicates only that Telecom has accepted that the item complies with minimum conditions for connection to its network. It indicates no endorsement of the product by Telecom, nor does it provide any sort of warranty by Telecom.

This cabling installation is NOT covered in New Zealand by Telecom's wiring maintenance service. In the event of service problems, the Disconnect Test Point should be used to determine whether or not the problem is due to the Telecom network (see page 28). If the fault appears to be in the cabling and equipment within the premises, contact the installer on page 36 for assistance. Only contact Telecom if the fault appears to be network-related. See page 26 for Troubleshooting information.



Safety Warnings

- Wiring work for telecommunications requires relevant knowledge and experience. Telephone line voltage can rise above 48VDC in certain circumstances. Do NOT work on your telephone wiring without the appropriate training and licensing as required by your State/Territory/Country.
- A qualified electrician should only carry out work on power supplies and outlets. Work by unqualified users may cause electric shock, fire, injury or death.
- Do NOT work on the Hills Home Hub, its contents, or wiring in the event of an electrical storm or lightning.
- Do NOT clean the contents of the Hills Home Hub with any liquid or wet cloth. Water penetration into the unit may cause short-circuit, electric shock and fire.
- Do NOT handle any equipment with wet hands as it may cause electric shock.
- No user serviceable parts, in the event of product failure, please contact your installer for assistance. Do NOT attempt repairs.
- Do NOT attempt to modify any of the components or wiring inside your Hills Home Hub except as instructed in this manual.
- If any power cables are broken or exposed, switch off power and replace.
- In case of smoke or burning smell from equipment (e.g. damaged by lightning) immediately discontinue use and contact your installer.
- Dropping or exposing products to shock may cause damage and malfunction.
- Only use approved cable, tools and components in your Hills Home Hub.
- Do NOT install your Hills Home Hub near wet or damp areas (e.g. laundry, kitchen, bathroom, outside, near and air conditioner or heater).
- When removing a cable from a socket, do NOT pull using the lead, hold the plug body firmly using dry hands then pull straight out.

Trademark

Hills Home Hub is a registered trademark of Hills Industries Ltd.

Copyright

©2006 Copyright Hills Industries Ltd. All rights reserved.

Disclaimer

Hills Industries Ltd reserves the right to change specifications or designs described in this manual without notice and without obligation. It is provided for general information only. For assistance on your specific installation please contact your installer.

Every effort has been made to ensure that this manual documents the operation of the Hills Home Hub. However, due to the on-going improvement and update of products, Hills Industries Ltd cannot guarantee the accuracy of printed material after the date of publication, nor can Hills Industries Ltd accept responsibility for errors or omissions. Revised manuals and update sheets will be published as deemed necessary.

Contents

<i>Notice</i>	2
<i>Telepermit Notice for New Zealand</i>	2
<i>Safety Warnings</i>	3
<i>Trademark</i>	3
<i>Copyright</i>	3
<i>Disclaimer</i>	3
<i>Contents</i>	4
<i>Preface</i>	5
Hills Home Hub	6
<i>Product Overview</i>	6
<i>Important Note</i>	7
<i>Security System Warning</i>	8
<i>Wall Plate Outlets</i>	9
<i>Wall Plates</i>	11
<i>Hills Home Hub Connections</i>	12
Connecting Phone & Data	13
<i>Description of Services</i>	13
<i>Technical Terms</i>	14
<i>Modules</i>	16
<i>Connecting a Telephone/Fax Machine/Dial-up Modem</i>	20
<i>Patching Phone and Data Outlets</i>	21
<i>Connecting ADSL</i>	24
Troubleshooting	26
<i>General</i>	27
<i>Telephone and Data</i>	28
Appendix	29
<i>Site Installation Log – Sample</i>	30
<i>Structured Cabling Outlets – Details – Sample</i>	31
<i>Structured Cabling Outlets – Summary – Sample</i>	32
<i>Site Installation Log</i>	33
<i>Structured Cabling Outlets – Details</i>	34
<i>Structured Cabling Outlets – Summary</i>	35
<i>Warranty Statements</i>	36

Preface

Welcome to your new home and thank you for choosing the Hills Home Hub. Your selected features will ensure that your home can be flexibly adapted to your changing lifestyle.

You are a part of the new generation of householders that are planning for today's and future needs for home technology and services in your home.

Contained in this booklet are the services you have selected and explanations on how you can maximise the benefits of your choices.

Hills is an Australian company that has been servicing the needs of home owners for over 55 years.

Below are some of our other products that you may consider for your household needs for both now and in the future.

Again welcome to your new Hills enabled home.



Hills Home Hub

This section includes an overview of your new Hills Home Hub and structured cabling and some of the connections it features.

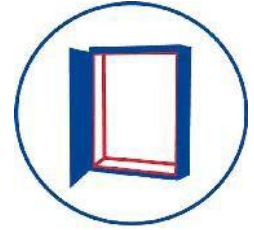

Product Overview

The Hills Home Hub is a service connection facility and is home to the devices that enable the delivery and distribution of various signals throughout your home via structured cabling.

It is important that you plan in which rooms you would like to access TV, video, audio, phone and the Internet. In order to access or share these signals, cables, modules and wall plate outlets containing various sockets need to be installed.

The (optional) Hills Security System may also be located in the Hills Home Hub along with all your structured cabling modules.



400 Series Hub



600 Series Hub



1000 Series Hub

Important Note

Not all services mentioned in this manual may be available in your home (or all rooms) unless they were requested at the time of installation. For various services to function as described by this manual (and other literature), certain modules, wall plates, sockets and cabling need to already be installed.

~~~~~

Provided that sufficient additional (spare) cabling was installed at the time of construction of your house, you may be able to add additional modules for additional features or capacity.

Spare cabling is usually only installed at the specific request of the owner/builder. If requested before the completion of the property, it is usually available at minimal additional cost due to significantly quicker installation.

Please contact your installer/builder for more information.

### Security System Warning

Note that there are some parts of the Hills Home Hub you should not touch including your security system wiring. The intelligent Hills Security System can detect tampering attempts to its security wiring and may notify your monitoring company of this if you have a monitored security system. This may incur call out fees for a patrol guard to visit your premises to check that everything is OK. Further fees may apply to rectify any problems.

If you have a “back to base monitoring” service (which usually incurs monthly fees), please make sure to notify your monitoring company of the time and duration that you are going to open the Hills Home Hub enclosure. Check with them if it will be OK to open the lid of your Hills Home Hub and ensure you have a valid PIN to disarm the security system should the alarm go off.

When you are working on equipment contained inside your Hills Home Hub, take care not to touch or disconnect any of the security wiring. It also uses power, so make sure to turn the power back on if you have turned it off.

Once you have finished working on the Hills Home Hub, firmly close and lock the lid. Then let your monitoring company know you have finished. Failure to do these may also trigger a false alarm or disable tamper monitoring on your enclosure!



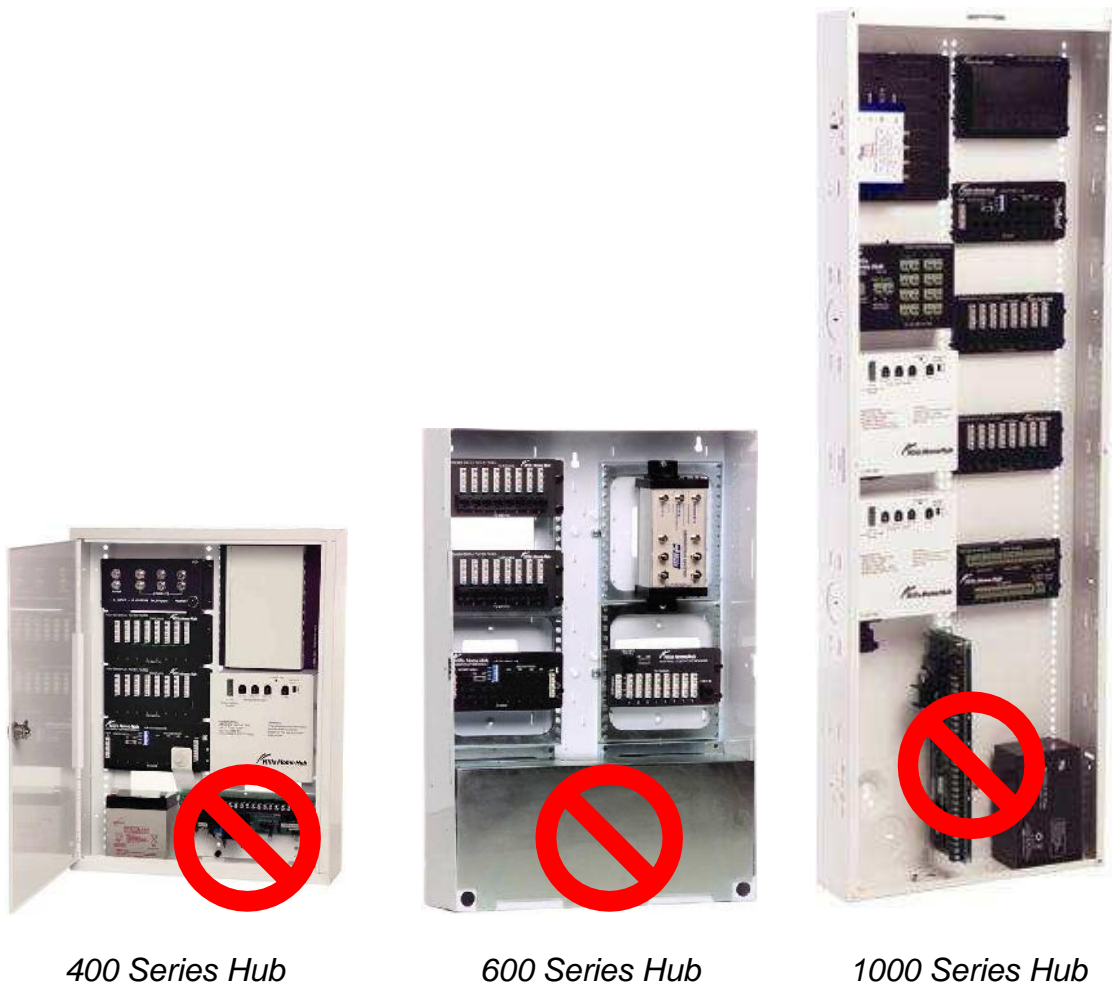









Some sample locations of the Hills Security System in your enclosure:





### Wall Plate Outlets

Here is a description of what each type of socket is used for. The section titled "Wall Plates" shows some sample wall plates with a combination of these sockets used for different purposes.

| Socket                                                                              | Cable Needed                                                                        | Possible Services                                                                                                                                                                                                  |
|-------------------------------------------------------------------------------------|-------------------------------------------------------------------------------------|--------------------------------------------------------------------------------------------------------------------------------------------------------------------------------------------------------------------|
|    |    | <p><b>RJ-45 Socket</b></p> <ul style="list-style-type: none"> <li>• Data (computers, internet, printers, photocopiers)</li> <li>• Telephone (thinner cable, RJ-11 or RJ12 plug on the end)</li> </ul>              |
|    |    | <p><b>PAL Socket</b></p> <ul style="list-style-type: none"> <li>• TV (antenna, remote viewing of DVDs and other home entertainment devices)</li> </ul>                                                             |
|  |  | <p><b>F-Type Socket</b></p> <ul style="list-style-type: none"> <li>• TV (antenna, remote viewing of DVD, VCR, Set Top Box etc)</li> <li>• Modulator (distribute signal from home entertainment devices)</li> </ul> |
|  |  | <p><b>3.5 mm Socket</b></p> <ul style="list-style-type: none"> <li>• InfraRed (control devices from other rooms)</li> <li>• Music Distribution (used as a music source input)</li> </ul>                           |
|  |  | <p><b>Speaker Post Socket</b></p> <ul style="list-style-type: none"> <li>• 5.1 Home Theatre Speakers (connect speaker wire to banana plugs and insert into socket, other end to music source)</li> </ul>           |
|  |  | <p><b>RCA Socket</b></p> <ul style="list-style-type: none"> <li>• Audio (usually red and white connectors)</li> <li>• Video (usually yellow, or Red Green Blue connectors)</li> </ul>                              |

### One Socket, One Service

Sockets are multi-purpose, but depending on how your system is configured, each wall plate outlet only provides one type of service. For example an "RJ-45 socket" may be configured for connecting a Phone or a Computer but not both simultaneously.

*The exception is with IR targets that use coaxial cable (thick cable with F-type connectors on the end) to distribute both TV signals and IR signals using a single wall plate outlet. Only used when retrofitting an IR distribution system without additional cabling.*



### Input or Output

Further, each socket may be an input or output. For example a "3.5mm socket" may be used as an input to connect your CD player to the Hills Home Music system to redistribute music throughout your house. Alternatively a 3.5mm socket may be configured to be an input or output (but not both) for the Hills Home IR Distribution system.

### Labelling

Because one single socket could be used for different services and could also be an input or output, it is essential to have all outlets properly labelled to avoid confusion. Ideally the installer has applied descriptive labels to them or has provided you with a floor plan with numbered outlets.

Contact your installer for assistance if you have difficulty identifying the correct outlets to use (i.e. if your wall plates are not labelled and you have not been supplied with any floor plans or documentation).

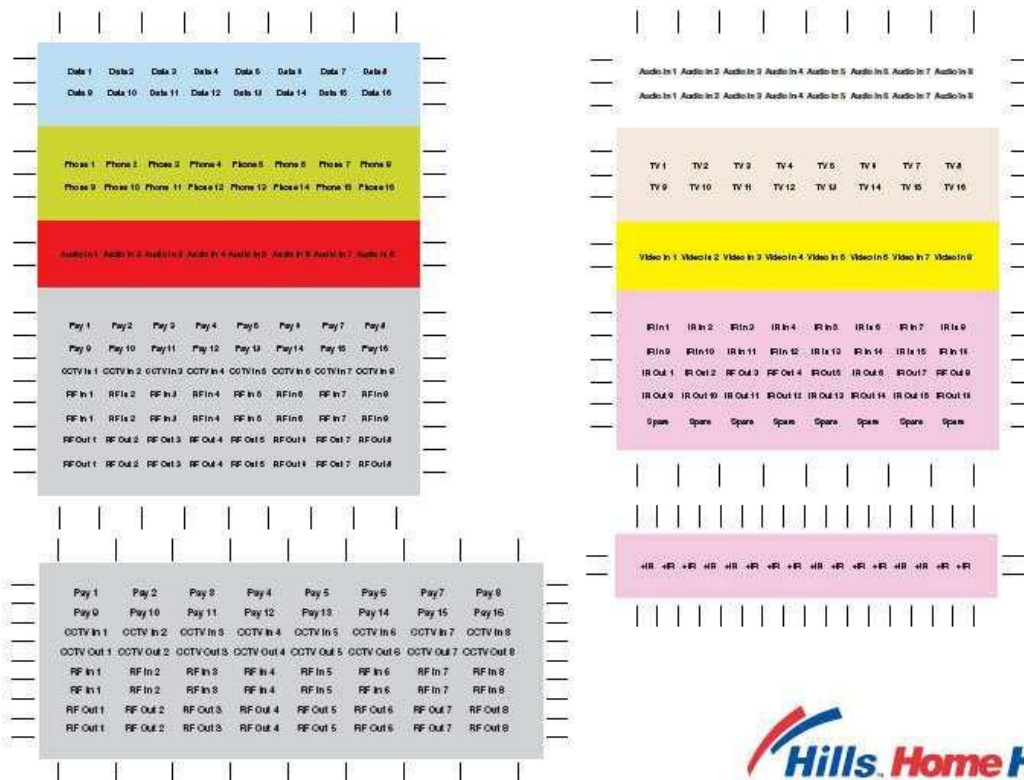

Example of labels that may be applied to wall plates



## Wall Plates

Your home will have a variety of wall plates with different outlets on them, see the section titles "Wall Plate Outlets" for a description of each.

Wall plates come in a variety of different designs, colours, and number of outlets. Here are some samples:



*Designed for connecting a Pay TV Set Top Box or Digital Video Recorder, Free to Air TV, and a Computer`*



*Designed for connecting a Phone and Personal Computer*



*Two wall plates combined to provide remote InfraRed control of up to 8 devices, a Data Outlet (e.g. Personal Computer, Gaming Console, Media Receiver), Pay TV, Free to Air TV, and RGB inputs (e.g. from a DVD player or AV Receiver to a projector)*

## Hills Home Hub Connections

### Easy Connections

With most services you simply plug-in your equipment into the correct wall plate outlet and everything should be ready for you to enjoy. This is the simplicity and convenience that your new Hills Home with structured cabling offers.

Depending on what options you have selected, these services may include:

- Telephone
- Data (computers, internet, home network, printers, etc)
- InfraRed remote control
- TV (Free-to-Air, Pay TV, DVD, etc)
- Multi-room Music Distribution
- Home Theatre Connections (e.g. projectors)
- 5.1 Surround Sound Home Theatre

This Owner's Manual will guide you through some examples on how to connect to these services provided you have the required cabling, modules, and wall plates already installed.

It does not cover how to operate 3<sup>rd</sup> party equipment or how to use these services. Some services will require initial configuration to make them work the way you want. For example, setting up your internet account or tuning your TV into certain channels. Always refer to the relevant manuals on how to configure your equipment (e.g. computers, modems, TV, STB, DVD player, AV receiver, stereo system, modulator, etc)

### Flexible Connections

The Hills Home Hub and structured cabling has been designed to allow you the flexibility to easily configure different features of your structured cabling system to suit your changing lifestyle.

Some of the services that allow you to easily adjust the wiring for are:

- Phone
- Data

Before making any changes, write down what your current wiring looks like (what cables are connected to where). Then read through the instructions completely and plan what you are going to change, making ensure you have the required equipment (e.g. cables).

### Assistance and Spare Parts

Please contact your installer if you have any questions regarding your installation, require additional parts, or wish to expand your installation. Service fees may apply.

For general information you may visit: [www.hillshomehub.com](http://www.hillshomehub.com)

# Connecting Phone & Data



This section is relevant to any telephone modules you may have purchased and goes through some examples on how to connect to your service.

---

## *Description of Services*

### Telephone

When installed with the Hills HTM-408S or HTM-408SRJ telephone modules, the Hills Home Hub becomes the heart of your telecommunications needs for both now and the future. Each module allows up to 4 incoming telephone lines to be connected to your home and directed to up to 8 room service locations.

Supporting the distribution of voice, fax, modem and other digital telephone services such as ISDN or DSL. It also connects (optionally) to the Hills Home Security System controller, giving priority to the security system over all other services in the event of an unauthorised entry or tampering of the Hills Home Security System. Phone services are delivered to the specified locations in your home through the use of specially configured Hills wall plates.

### Data

Companies have long enjoyed the benefits of sharing resources and improving communications by networking computers and peripherals together. The Hills HDM-808 Data / Patch Panel prepares your home for this technology by providing data connections to specially configured Hills wall plates around your home via the Hills Home Wiring network and the Hills Home Hub.

At this point your home has now been pre-wired for data communications to utilise the data outlets in your home. If you have requested structured cabling for data, then a HES-108 Hills Ethernet Hub will be installed in your Hills Home Hub. It is capable of connecting up to eight pre-wired service outlet locations as a Local Area Network and you are now ready to take advantage of networked high speed internet and resource sharing throughout your home.

Remember to consult your installer about connecting your computers to the Hills Home Data network, as your computers will need to be configured to maximise the benefits.

Contact your telecommunications provider and Internet Service Provider for telecommunications services and Internet access (fees will apply).

## Technical Terms

### RJ-45, RJ-11, and RJ-12 Sockets

These refer to the different types of sockets and plugs used for connecting equipment like telephones and computers. These sockets (rectangular holes with gold pins in them) are also referred to as “keystone jacks”.

On the left is an RJ-45 socket and a cable with an RJ-45 plug on the end that will allow it to fit into the socket.

Commonly used for connecting computer equipment like PCs and modems to a network.



On the right is an RJ-11 socket (also called RJ-12) and a telephone cable with an RJ-11 plug on the end that will allow it to fit into the socket.

Commonly used for connecting telephones and faxes.

*Image is for representation only, actual sockets/cable may look different.*

The Hills Home Hub uses RJ-45 sockets throughout the house. Although not recommended, cables with RJ-11 or RJ-12 connectors on the end will fit into a RJ-45 socket and operate correctly. Ideally a reducer should be inserted into a RJ-45 socket to change it into a RJ-11/12 socket. RJ-11/12 is not used in New Zealand.

### Patch Cables

A patch cable in the Hills Home Hub is a short cable (~ 10-100cm in length) with RJ-45 connectors on each end. They come in a variety of colours and this does not affect their performance in any way.



There are two types of patch cables available – “straight-through” and “cross-over”. All equipment in the Hills Home Hub uses the more common “straight-through” patch cable.

Inside the Hills Home Hub they are used to connect an ADSL/Cable modem to the Ethernet Hub; and to connect Telephone Modules and Ethernet Hubs to Data Patch Panels. This effectively connects phone lines and data outlets to rooms.

In rooms, patch cables are used to connect data devices (e.g. computers, printers, ethernet switches, wireless routers, gaming consoles, etc) to wall plate outlets and each other. This allows you to easily create a home network (i.e. LAN – Local Area Network) to share equipment and connect to the Internet without messy cabling between rooms.

## REN and RN – Ringer Equivalence Number

When connecting telephone and faxes you need to be careful of something called “REN” or “Ringer Equivalence Number”. In Australia it has a value of 3. In New Zealand it is abbreviated to “RN” and has a value of 5.

This basically is the maximum number of phones, faxes, ADSL filters, dialup modems or telecommunications equipment that you can connect in your home. Your equipment should have the REN (or RN) printed on the bottom of it or in the user manual it came with.

Most telephones have a REN of 1. This means that at any one time you cannot connect more than 3 telephones in your home (if each is rated at REN 1) even if, for example, you have 16 telephone sockets. Just add up the RENs of all the equipment you want to connect and make sure it is no more than 3 in Australia, and no more than 5 in New Zealand.

REN and RN apply to each telephone line. Most residential homes have one line.

If you exceed this number then some equipment may not work. For example, the phone might not ring!

If you connect too many devices just unplug some devices until you have a total REN of 3 or less (5 for New Zealand).

If you require more phones simultaneously connected, try adding cordless phones or consider purchasing a Hills PABX for a Small Office/Home Office (SOHO), which supports up to 16 simultaneous phones.

This limit does not apply with data-only equipment (e.g computers, routers) which are connected on the customer's side of an approved modem.

## Modules

Note: Images are representative only. We are continually improving our products so the actual product you purchase may look different to those pictured here.

### HTM-408S Telephone Module

These are used for connecting phone lines directly to room outlets (no patching facilities).

Do not touch any components other than **C£**, **®**, **®**, and **G)**.

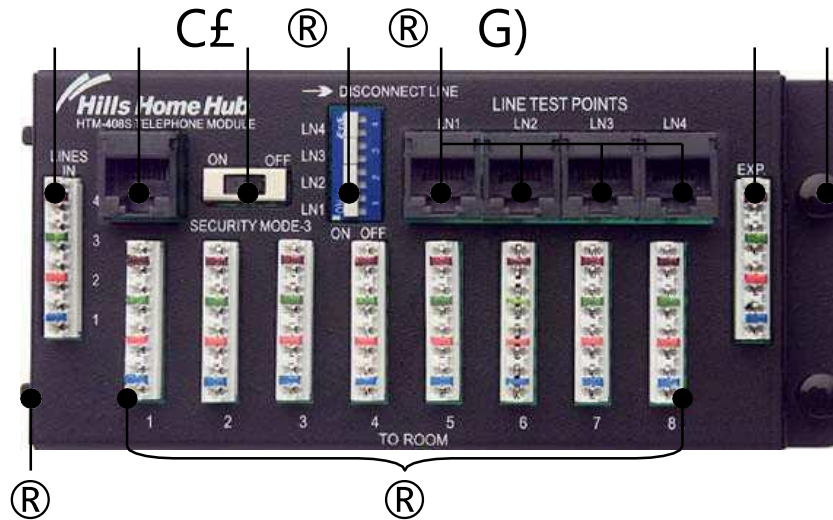

|           |                                                                                                                                                                                                                       |          |                                                                                                     |
|-----------|-----------------------------------------------------------------------------------------------------------------------------------------------------------------------------------------------------------------------|----------|-----------------------------------------------------------------------------------------------------|
|           | Incoming Telephone Lines<br>One cable supports up to 4 lines                                                                                                                                                          |          | Expansion Connector<br>Used to connect to another telephone module                                  |
| <b>C£</b> | Mode 3 Socket<br>An RJ-45 socket for connecting to the Hills Security System                                                                                                                                          |          | Snap rivets<br>Used to secure the module to the Hills Home Hub enclosure                            |
| <b>®</b>  | Mode 3 Switch<br>If nothing connected to <b>C£</b> leave OFF<br>If something connected to <b>C£</b> leave ON                                                                                                          | <b>®</b> | Attachment Legs<br>Used to secure the module to the Hills Home Hub enclosure                        |
| <b>®</b>  | Line Disconnect Switches<br>One switch for each incoming telephone line. Switch to ON position for normal operation. For testing, switch to OFF position to disconnect all internal equipment connected to <b>®</b> . | <b>®</b> | Telephone Room Connectors<br>Used to connect telephone lines directly to up to 8 wall plate outlets |
| <b>G)</b> | Line Test Points<br>One RJ-45 socket for each incoming telephone line. For testing, switch <b>®</b> OFF, connect a telephone to the relevant socket and try dialing out and receiving calls.                          |          |                                                                                                     |



### HTM-408SRJ Telephone Module

These are used for connecting phone lines to room outlets via a HDM-808 Data / Patch Panel. Do not touch any components other than **C£**, **®**, **G)**, and **®**.

Never connect a telephone socket (labelled below as **C£**, **G)**, or **®**) to a data socket on data equipment (e.g. **G)** on a HES-108 Ethernet hub). This can potentially damage telephone and data equipment and can be illegal!

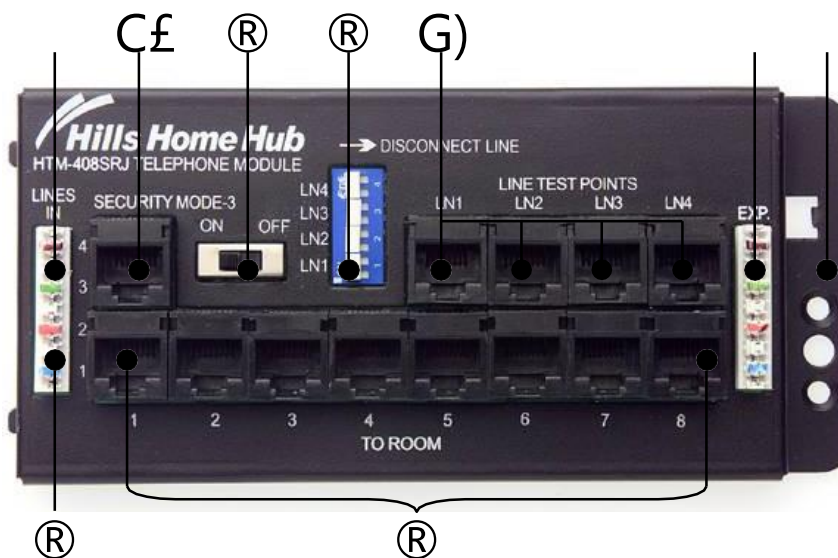

|           |                                                                                                                                                                                                                       |          |                                                                                                                      |
|-----------|-----------------------------------------------------------------------------------------------------------------------------------------------------------------------------------------------------------------------|----------|----------------------------------------------------------------------------------------------------------------------|
|           | Incoming Telephone Lines<br>One cable supports up to 4 lines                                                                                                                                                          |          | Expansion Connector<br>Used to connect to another telephone module                                                   |
| <b>C£</b> | Mode 3 Socket<br>An RJ-45 socket for connecting to the Hills Security System                                                                                                                                          |          | Snap rivets<br>Used to secure the module to the Hills Home Hub enclosure                                             |
| <b>®</b>  | Mode 3 Switch<br>If nothing connected to <b>C£</b> leave OFF<br>If something connected to <b>C£</b> leave ON                                                                                                          | <b>®</b> | Attachment Legs<br>Used to secure the module to the Hills Home Hub enclosure                                         |
| <b>®</b>  | Line Disconnect Switches<br>One switch for each incoming telephone line. Switch to ON position for normal operation. For testing, switch to OFF position to disconnect all internal equipment connected to <b>®</b> . | <b>®</b> | Telephone Room Connectors<br>Used to connect telephone lines to 8 locations using Patch Cables to the HDM-808 Module |
| <b>G)</b> | Line Test Points<br>One RJ-45 socket for each incoming telephone line. For testing, switch <b>®</b> OFF, connect a telephone to the relevant socket and try dialing out and receiving calls.                          |          |                                                                                                                      |

### HDM-808 Data / Patch Panel

These are used to connect both phone lines and data equipment (e.g. computer, modem or printer) to room outlets. It is designed to be used with a HTM-408SRJ Telephone Module and a HES-108 Ethernet Hub. Do not touch any components other than ®.

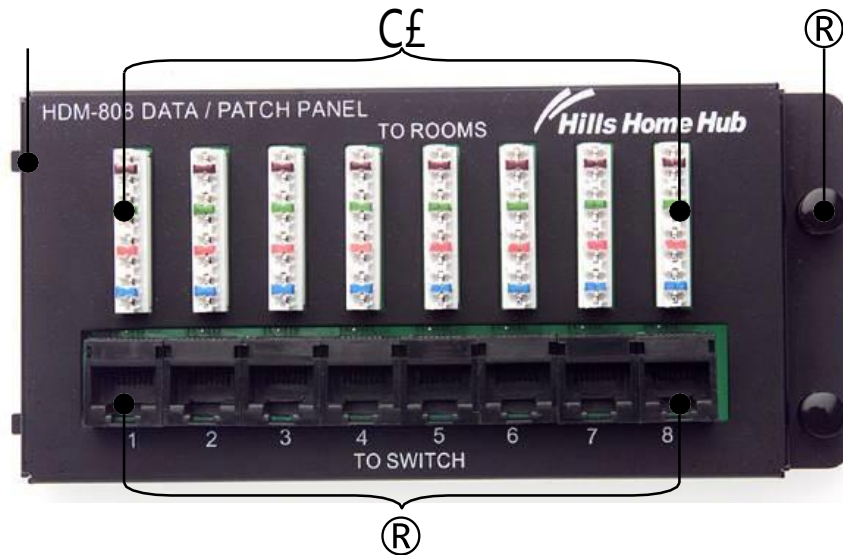

|    |                                                                                                                     |   |                                                                                                                            |
|----|---------------------------------------------------------------------------------------------------------------------|---|----------------------------------------------------------------------------------------------------------------------------|
|    | Attachment Legs<br>Used to secure the module to the Hills Home Hub enclosure                                        | ® | Snap rivets<br>Used to secure the module to the Hills Home Hub enclosure                                                   |
| Cf | Telephone / Data Room Connectors<br>Used to connect telephone lines or data equipment to up to 8 wall plate outlets | ® | Telephone / Data Patch Connectors<br>Used to connect to sockets on the HTM-408SRJ Telephone Module or HES-108 Ethernet Hub |

### HES-108 Ethernet Hub

These are used for connecting data equipment (e.g. computer, modem or printer) to room outlets via a HDM-808 Data / Patch Panel.

Never connect outlets from a telephone module (labelled **C£**, **G**), or **®** on the HTM-408S or HTM-408SRJ) to an Ethernet Hub's outlets (**G**). This can potentially damage telephone and data equipment and can be illegal!

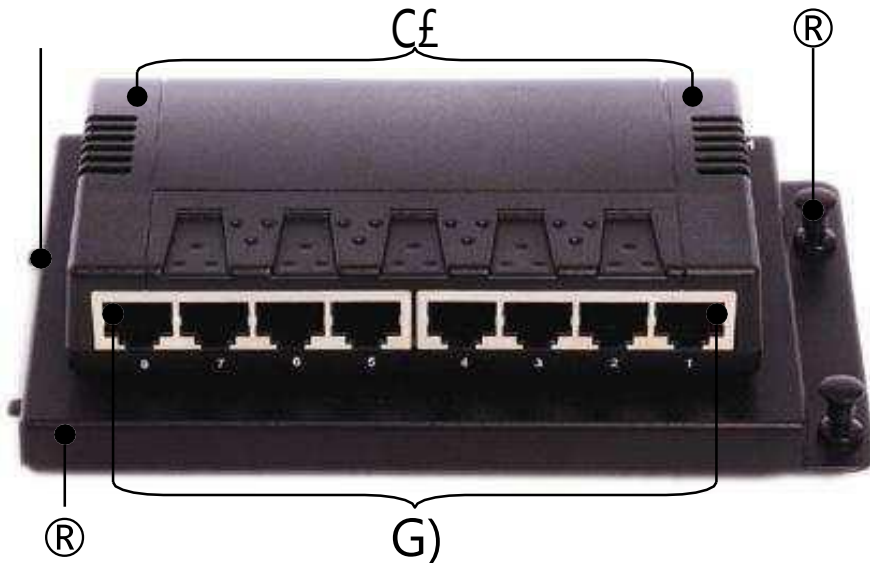

|    |                                                                                                 |    |                                                                                                         |
|----|-------------------------------------------------------------------------------------------------|----|---------------------------------------------------------------------------------------------------------|
|    | Attachment Legs<br>Used to secure the module to the Hills Home Hub enclosure                    | ®  | Mounting Plate<br>Used to secure the Ethernet Hub to the Hills Home Hub enclosure                       |
| C£ | Activity Lights<br>LED lights blink to let you know what outlets are connected and transmitting | G) | Room Connectors<br>Used to connect data outlets to 8 locations using Patch Cables to the HDM-808 Module |
| ®  | Snap rivets<br>Used to secure the module to the Hills Home Hub enclosure                        |    |                                                                                                         |

## Connecting a Telephone/Fax Machine/Dial-up Modem

Connecting a phone, fax machine, or dial-up modem in your home with a Hills Home Hub and structured cabling is very simple.

Just locate an RJ-45 socket labelled "Phone":

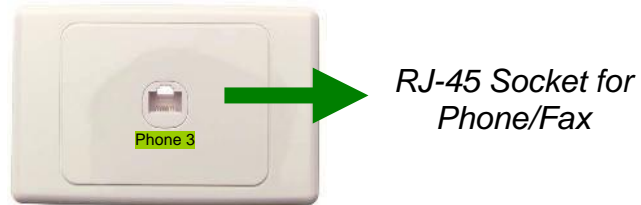

And plug in your phone, fax machine, or dial-up modem. It's that easy!

If your wall plates are not labelled try looking for the floor plan to identify which socket is for phone.

If you can't locate a floor plan then you can try plugging your phone into a RJ45 socket and testing whether it works by dialling out. If not, try another socket.

### Note

Make sure you do not connect more equipment than your home supports. Otherwise your equipment may stop working. This is determined by your REN. Read the Technical Terms section titled "REN and RN – Ringer Equivalence Number" for more information.

## Patching Phone and Data Outlets

You may have a single RJ-45 socket on a wall plate that is set up for Phone, and you want to connect a computer instead (or vice-versa and change a Data socket into a Phone socket).

The Hills Home Hub allows you to easily change phone and data sockets:

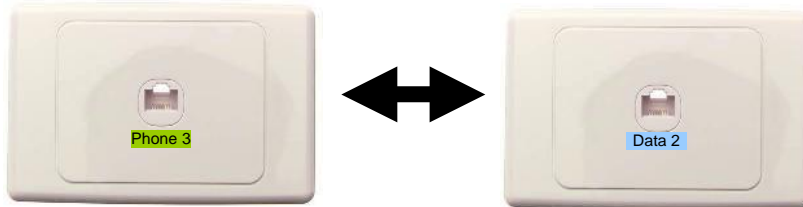

## Requirements

Your home must be set up for patching services, which requires the following in your Hills Home Hub enclosure:

- HES-108 Ethernet Hub
- HDM-808 Data / Patch Panel
- HTM-408SRJ Telephone Module (if only a HTM-408S is present you will not be able to patch phone services, contact your installer for assistance)
- and some patch cables (which should already be connected)

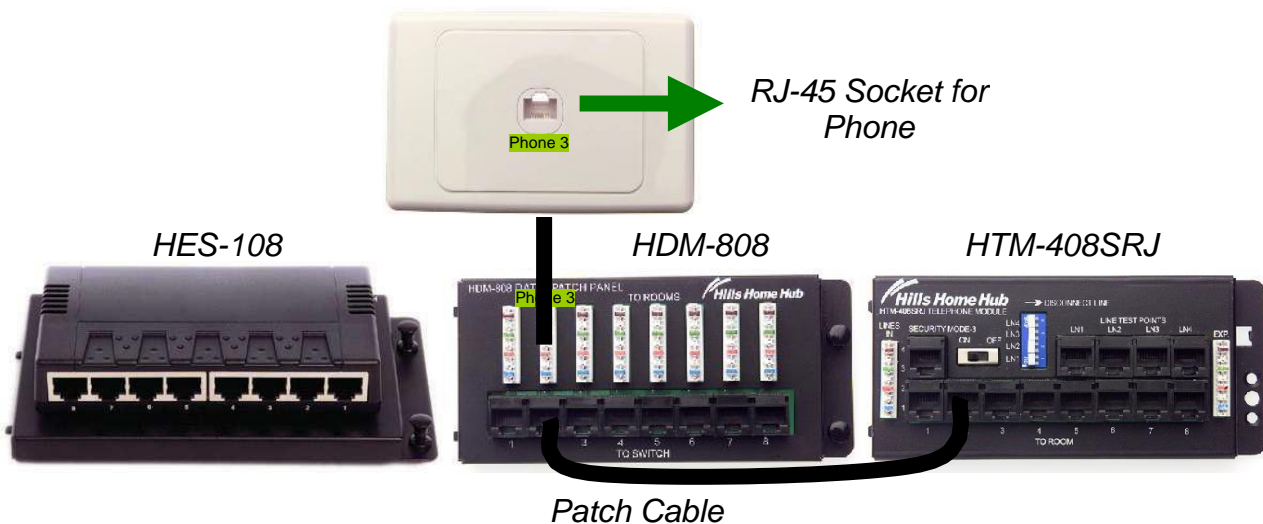

## Note

You are free to increase the number of telephone sockets in your house up to the maximum number supported by your installation (depends on the number of modules and wall plates installed).

But do not connect more equipment (e.g. phones) to wall sockets than your home supports. Otherwise your equipment may stop working. This is determined by your REN. Read the Technical Terms section titled "REN and RN – Ringer Equivalence Number" for more information.

## Quick Start

Example of converting a Phone Socket into a Data Socket

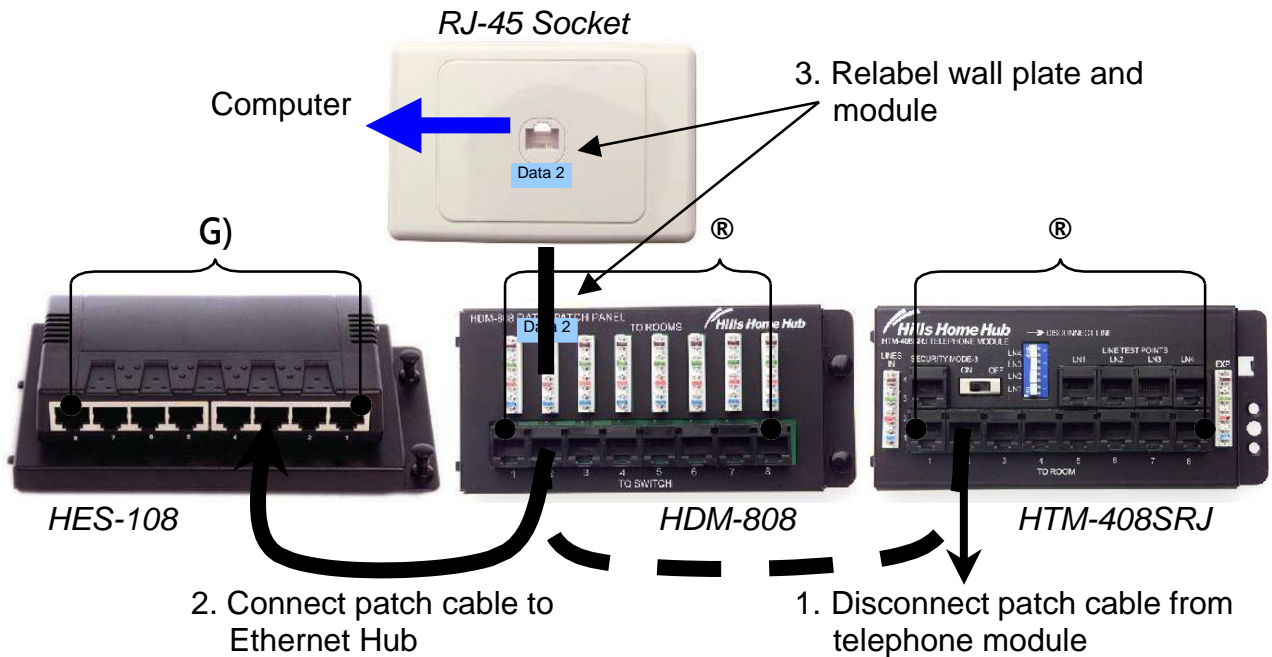

## Detailed Instructions

1. Read the section "Security System Warning" on page 8.
2. Open the Hills Home Hub and check you have the required modules for patching.
3. Locate the existing socket and patch cable already connected on the HDM-808 Data/Patch Panel (®) corresponding to the wall plate socket you want to change. Labels on the module and wall plate (or a floor plan) will help. Otherwise read the next section for "Additional Help".
4. Unplug the opposite end of the patch cable from the existing telephone or data module (i.e. Telephone Module ® or Ethernet Hub G)).
5. Plug it firmly into the module with the desired service (i.e. sockets on the bottom of Telephone Module labelled ® or Ethernet Hub sockets labelled G)). In this example we are changing from a phone socket into a data socket, so we unplug one end of the patch cable from the Telephone Module ® and plug it into a free socket on a Ethernet Hub G).
6. Test that your new socket works.
7. Remember to relabel your wall plate and modules.

### Additional Help

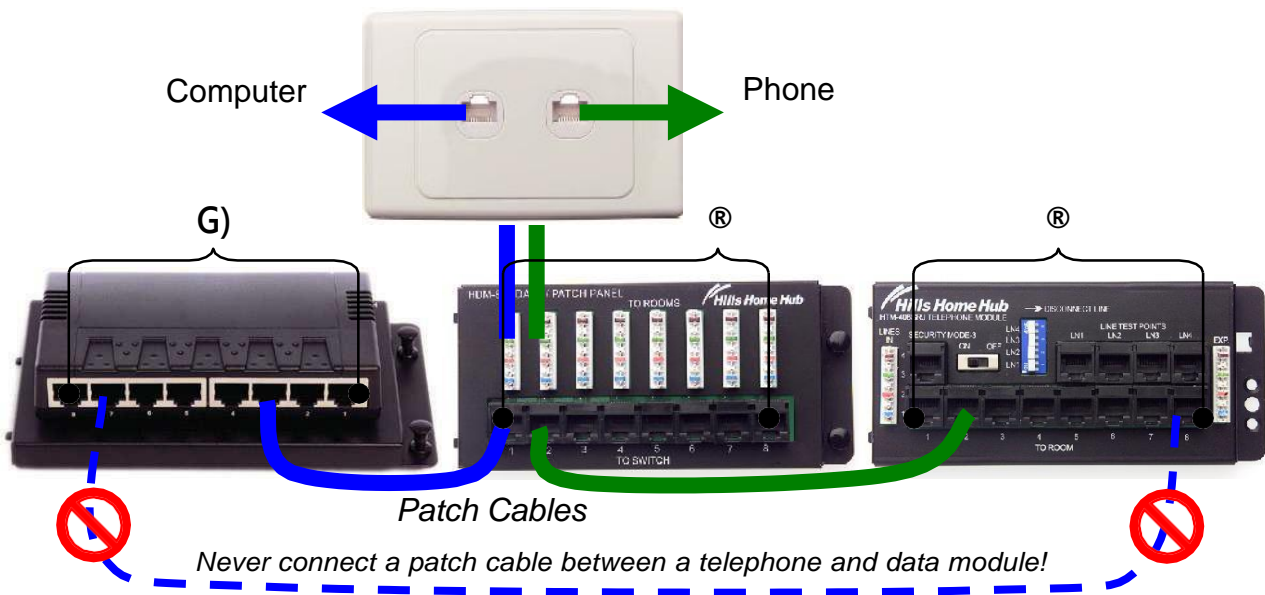

If you don't know which socket is the right one to change on the HDM-808 Data/Patch Panel:

When you want to change a telephone socket to a data socket.

1. Plug in a telephone into the wall socket you want to change (keeping in mind you cannot exceed a REN of 3 as noted before).
2. Unplug in turn, each of the patch cables connected to the bottom of the HDM-808 Data/Patch Panel (®) until the phone does not work. This is the correct patch cable to use.
3. Plug it back into the HDM-808 Data/Patch Panel (®).
4. Unplug the other end of the patch cable from the HTM-408SRJ Telephone module (®), and insert it into a free socket on the HES-108 Ethernet Hub (G)).

When you want to change a data socket to a telephone socket.

1. Plug in a computer into the wall socket you want to change and turn it on, check that your network functions.
2. Unplug in turn, each of the patch cables connected to the bottom of the HDM-808 Data/Patch Panel (®) until that computer tells you that the cable is unplugged or your internet no longer works. This is the correct patch cable to use.

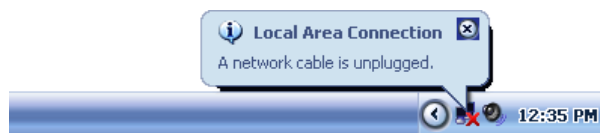

3. Plug it back into the HDM-808 Data/Patch Panel (®).
4. Unplug the other end of the patch cable from the HES-108 Ethernet Hub (G)), and insert it into a free socket on the HTM-408SRJ Telephone Module (®).

## Connecting ADSL

If you have subscribed to an ADSL service for high speed internet, you may wish to install the modem and ADSL filter in a central location for convenience. This means that micro ADSL filters will not be needed at each phone socket in your home.

After setting up your ADSL connection and home network, you will be able to share equipment (e.g. share files and printers), and access high speed internet using your ADSL connection in multiple rooms of your home.

### Requirements

- HES-108 Ethernet Hub
- HDM-808 Data / Patch Panel
- HTM-408SRJ Telephone Module or HTM-408S Telephone Module
- Mode 3 ADSL2+ Filter (must be 4 wire filter, part number S1350 recommended)
- A terminator plug if you do not have an alarm system
- ADSL Modem/Router (must have router feature to share internet connection)
- Accessory Plate (optional)
- and some patch cables

### Warning

Never connect a telephone socket to a data socket (e.g. from the ADSL filter to a data socket on your ADSL modem). This can potentially damage your equipment and may be illegal.



## Quick Start

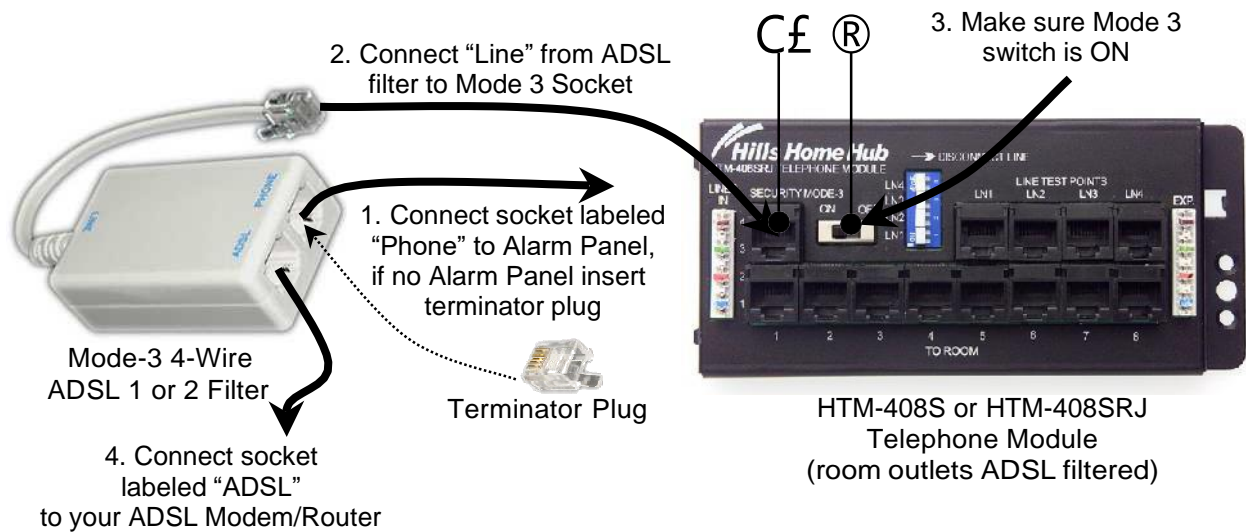

## Detailed Instructions

1. Read the section "Security System Warning" on page 8.
2. Open the Hills Home Hub and check you have the required parts.
3. Locate your telephone module and note whether anything is plugged into the Mode 3 Socket (C£). If there is a cable connected, unplug it from the socket and insert it firmly into your ADSL filter socket marked "Alarm Panel" or "Phone" (or similar). If no existing cable is connected, firmly insert the terminator plug into this socket on the ADSL filter. *(The terminator plug is a RJ-45 plug with two short loops of wires linking pins 3 to 4 and 5 to 6.)*
4. Plug the end of your ADSL filter marked "Line" (or similar) firmly into the Mode 3 Socket (C£). A patch cable may come with the ADSL filter for this.
5. Make sure the Mode 3 Switch (R) is in the ON position.
6. Find a suitable place to install your ADSL modem near or inside the Hills Home Hub (space permitting). An optional accessory plate is available from your installer to attach to your ADSL modem before installing inside the Hills Home Hub enclosure. Note that your ADSL modem may require power, so take this into consideration.
7. Using a patch cable, connect the socket on the ADSL filter marked "ADSL" (or similar) to your ADSL modem.
8. Turn on your ADSL modem and test that your ADSL connection works from a room with a data socket. You will need to configure your computer and ADSL modem. Consult your computer equipment manuals and your ADSL provider for details. For assistance contact an IT professional.
9. Contact your alarm monitoring company (if you have one) and ask them to test whether your alarm panel is functioning correctly now that you have connected ADSL.

# Troubleshooting

This section covers some solutions to common problems that you may encounter due to incorrect configuration or missing parts.

---

## General

The Hills Home Hub and structured wiring contains few components that need configuration once it is installed. We hope that your installation will provide you with many years of maintenance-free convenience and enjoyment.

The majority of issues that may appear can be solved by:

1. Checking that you are using the correct wall plate outlet  
A single type of outlet may be used for a variety of services but (usually) only one service at a time and also as an input or output and not both simultaneously. This is why proper labelling or a labelled floor plan is essential. If you have another outlet on the wall plate try that and see if it works.

For example, a wall plate may have multiple F-type outlets that all look the same. Some may be from the antenna (for normal Free-To-Air TV) and others from a satellite dish (for Pay TV), and maybe even another that is intended for a modulator.

2. Checking that you are using the right cable to connect to the wall plate  
Perhaps the cable you have connected to the wall plate is for another device. This especially applies around your home entertainment area(s) with many cables.

For example, you may have accidentally plugged your TV (instead of your VCR) into an antenna (FTA) wall plate outlet; this could stop you from viewing or recording a TV show.

3. Checking that all required modules and devices are turned on  
For example, in order to watch Pay TV your Set-Top-Box must be plugged into a wall outlet, then to your TV or VCR. All these devices need to be turned on and set to the right channel for the channel to appear on your TV. And if you want to watch your VCR from another room, your modulator needs to be on.

In rare circumstances the power to the Hills Home Hub may be switched off. For example, a circuit breaker may have tripped or someone turned it off and forgot to turn it back on. This will also turn off some modules located in the Hills Home Hub. Check that any power sockets that supply power to your Hills Home Hub are switched on and function normally (e.g. plug in a fan and switch it on to verify).

Some Hills Home Hubs have power socket(s) located inside the enclosure. Read the section "Security System Warning" on page 8, then open the lid of the Hills Home Hub and verify that these power sockets are functioning. Certain modules (e.g. power supplies and active splitter) located inside the enclosure will have a red light to indicate they are receiving power.

4. Checking that you have configured your device correctly  
For example, a TV will not work out-of-the-box. You will first need to tune it after you plug it into an appropriate wall outlet. And a computer will not automatically connect to the internet after you plug it into an appropriate outlet. You first need to set up your computer and modem with the required settings.

See your device's manual for more information and instructions.

## Telephone and Data

### My phone, fax or telecommunications equipment isn't working

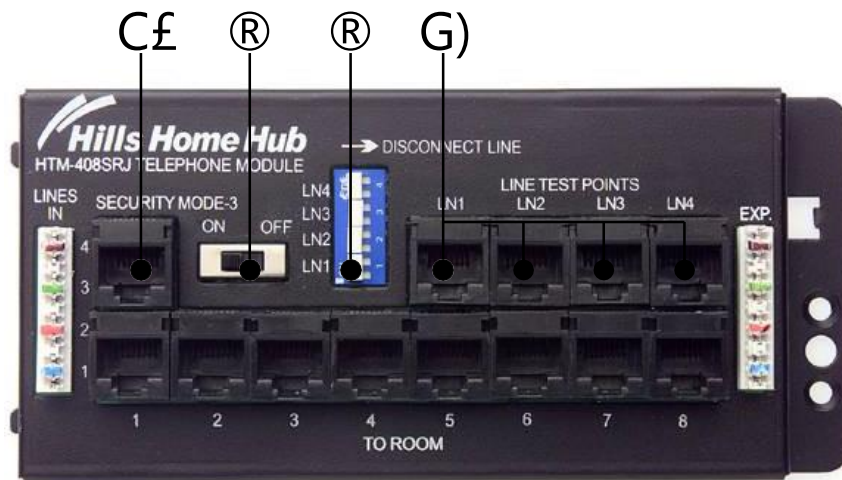

#### Check your telephone equipment

- Try unplugging equipment from the wall and then try again.
- Try another wall socket (you may have accidentally used a data socket).
- Try dialling and receiving calls from another room.
- If phones don't ring read the section "REN and RN – Ringer Equivalence Number".
- Try swapping with a phone from another room you know works.
- If you have a second phone line, try dialling/receiving calls from that number.

#### Check your Hills Home Hub

- Read the section "Security System Warning" on page 8.
- Open the lid on your Hills Home Hub.
- Check that all cables are firmly plugged in and that there are no loose wires.
- If you have something connected to the Mode 3 Socket (C£) make sure that the Mode 3 Switch (R) is in the ON position.
- The Disconnect Switch for the number of phone lines you have should be in the ON position (most people have only one phone line, so the "LN1" switch should be on).
- Check that patching is correct (more information on page 21).

#### Disconnect switches (R)

These switches allow you to disconnect your home's telecommunications equipment from the telecommunications provider to assist in isolating possible locations of faults.

- Push the disconnect line switches (R) to the OFF position.
- Plug in a telephone into the left Line Test Point (G) if you are having issues with line 1 (standard residential telephone line).
- Try to make a telephone call and then try to receive a call (e.g. using a mobile phone to dial your home number, or dial to/from line 2 if available).
- If you can't make and receive calls then the problem may be with the telecommunications provider. Contact them for assistance.
- If you can do both then the problem may be with your cabling or your equipment. Contact your installer for assistance. Service fees may apply.
- Restore the disconnect line switch(es) (R) back to the ON position.

# Appendix

This section contains additional resources which may be of interest to your Hills Home Hub and structured cabling installation.

---

## Site Installation Log – Sample

Your installer should have completed a simple floor plan (that looks similar to this page) showing the number and type of outlets installed in your home. It may have outlets labelled with a legend as below, or numbered like the example on the next page.



Date of Completion: 06 /06 /2006

Name of Installer: Michael Smith

Contact Number: 02 1234 5678

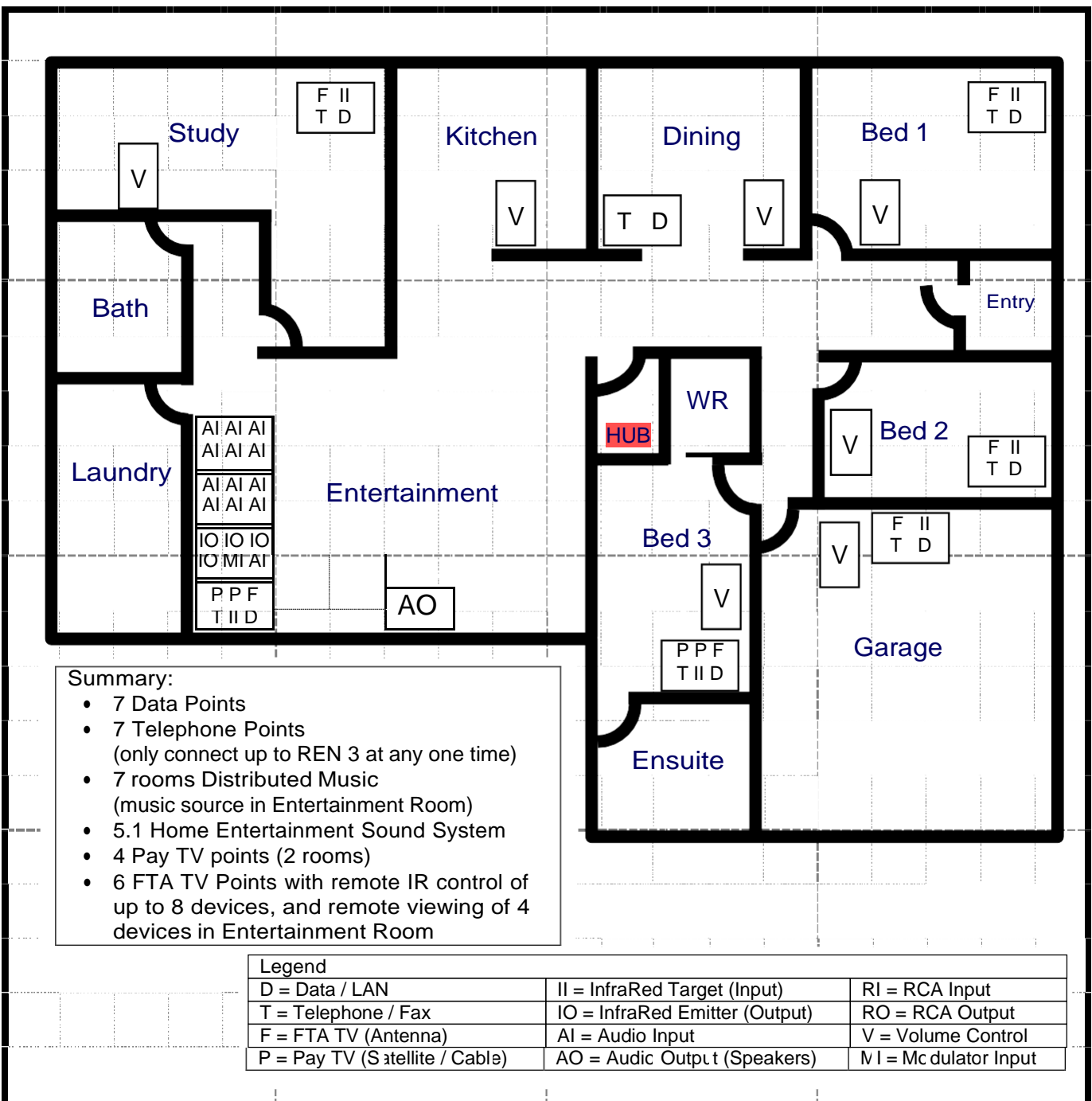

**Summary:**

- 7 Data Points
- 7 Telephone Points (only connect up to REN 3 at any one time)
- 7 rooms Distributed Music (music source in Entertainment Room)
- 5.1 Home Entertainment Sound System
- 4 Pay TV points (2 rooms)
- 6 FTA TV Points with remote IR control of up to 8 devices, and remote viewing of 4 devices in Entertainment Room

| Legend                         |                                |                      |
|--------------------------------|--------------------------------|----------------------|
| D = Data / LAN                 | II = InfraRed Target (Input)   | RI = RCA Input       |
| T = Telephone / Fax            | IO = InfraRed Emitter (Output) | RO = RCA Output      |
| F = FTA TV (Antenna)           | AI = Audio Input               | V = Volume Control   |
| P = Pay TV (Satellite / Cable) | AO = Audio Output (Speakers)   | MI = Modulator Input |

### Structured Cabling Outlets – Details – Sample

Your installer should have completed a simple page like this example showing what service each numbered outlet provides in your house. Each outlet in your home should be numbered according to this sheet, or be labelled on a floor plan as on the previous page.

| Outlet No. | Service (tick relevant box or write in) |       |        |        |       |        |                      |
|------------|-----------------------------------------|-------|--------|--------|-------|--------|----------------------|
|            | Data                                    | Phone | FTA TV | Pay TV | IR In | IR Out | Other                |
| 1          |                                         |       | ✓      |        |       |        |                      |
| 2          |                                         |       |        |        | ✓     |        |                      |
| 3          |                                         | ✓     |        |        |       |        |                      |
| 4          | ✓                                       |       |        |        |       |        |                      |
| 5          |                                         | ✓     |        |        |       |        |                      |
| 6          | ✓                                       |       |        |        |       |        |                      |
| 7          |                                         |       | ✓      |        |       |        |                      |
| 8          |                                         |       |        |        | ✓     |        |                      |
| 9          |                                         | ✓     |        |        |       |        |                      |
| 10         | ✓                                       |       |        |        |       |        |                      |
| 11         |                                         |       |        |        |       | ✓      |                      |
| 12         |                                         |       |        |        |       | ✓      |                      |
| 13         |                                         |       |        |        |       | ✓      |                      |
| 14         |                                         |       |        |        |       | ✓      |                      |
| 15         |                                         |       |        |        |       |        | Modulator In         |
| 16         |                                         |       |        |        |       |        | Distributed Music In |
| 17         |                                         |       |        | ✓      |       |        |                      |
| 18         |                                         |       |        | ✓      |       |        |                      |
| 19         |                                         |       | ✓      |        |       |        |                      |
| 20         |                                         | ✓     |        |        |       |        |                      |
| 21         |                                         |       |        |        | ✓     |        |                      |
| 22         | ✓                                       |       |        |        |       |        |                      |
| 23         |                                         |       |        | ✓      |       |        |                      |
| 24         |                                         |       |        | ✓      |       |        |                      |
| 25         |                                         |       | ✓      |        |       |        |                      |
| 26         |                                         | ✓     |        |        |       |        |                      |
| 27         |                                         |       |        |        | ✓     |        |                      |
| 28         | ✓                                       |       |        |        |       |        |                      |
| 29         |                                         |       | ✓      |        |       |        |                      |
| 30         |                                         |       |        |        | ✓     |        |                      |
| 31         |                                         | ✓     |        |        |       |        |                      |
| 32         | ✓                                       |       |        |        |       |        |                      |
| 33         |                                         |       | ✓      |        |       |        |                      |
| 34         |                                         |       |        |        | ✓     |        |                      |
| 35         |                                         | ✓     |        |        |       |        |                      |
| 36         | ✓                                       |       |        |        |       |        |                      |

### Structured Cabling Outlets – Summary – Sample

Your installer should have completed a simple page like this example showing what features are available in each room of your house.

| Room          | Service      |              |                      |              |               |             |           |
|---------------|--------------|--------------|----------------------|--------------|---------------|-------------|-----------|
|               | Data         | Phone        | FTA TV               | Pay TV       | IR            | Dist. Music | 5.1 Audio |
| Bed 1         | 1            | 1            | 1                    |              | 1 In          | Yes         |           |
| Bed 2         | 1            | 1            | 1                    |              | 1 In          | Yes         |           |
| Bed 3         | 1            | 1            | 1                    | 2            | 1 In          | Yes         |           |
| Study         | 1            | 1            | 1                    |              | 1 In          | Yes         |           |
| Kitchen       |              |              |                      |              |               | Yes         |           |
| Dining        | 1            | 1            |                      |              |               | Yes         |           |
| Entertainment | 1            | 1            | 1 +<br>Modulator     | 2            | 1 In<br>4 Out | 1 In        | Yes       |
| Garage        | 1            | 1            | 1                    |              | 1 In          | Yes         |           |
| <b>TOTAL</b>  | 7<br>outlets | 7<br>outlets | 6 outlets<br>1 inlet | 4<br>outlets | 6 In<br>4 Out | 7<br>rooms  | 1<br>room |

#### Notes

---



---



---



---



---



---



---



---

Note that with most standard residential telephone services you can only connect equipment (e.g. telephones) up to a maximum rating of REN 3 (5 for NZ) at any one time. Look on your telephone equipment to determine the REN rating and ensure that your home does not exceed a total of 3. If you require more phones try adding cordless phones or consider purchasing a Hills PABX for a Small Office/Home Office (SOHO).





### Structured Cabling Outlets – Details

[Installer to complete, copy if more room needed]

| Outlet No. | Service (tick relevant box or write in) |       |        |        |       |        |       |
|------------|-----------------------------------------|-------|--------|--------|-------|--------|-------|
|            | Data                                    | Phone | FTA TV | Pay TV | IR In | IR Out | Other |
| 1          |                                         |       |        |        |       |        |       |
| 2          |                                         |       |        |        |       |        |       |
| 3          |                                         |       |        |        |       |        |       |
| 4          |                                         |       |        |        |       |        |       |
| 5          |                                         |       |        |        |       |        |       |
| 6          |                                         |       |        |        |       |        |       |
| 7          |                                         |       |        |        |       |        |       |
| 8          |                                         |       |        |        |       |        |       |
| 9          |                                         |       |        |        |       |        |       |
| 10         |                                         |       |        |        |       |        |       |
| 11         |                                         |       |        |        |       |        |       |
| 12         |                                         |       |        |        |       |        |       |
| 13         |                                         |       |        |        |       |        |       |
| 14         |                                         |       |        |        |       |        |       |
| 15         |                                         |       |        |        |       |        |       |
| 16         |                                         |       |        |        |       |        |       |
| 17         |                                         |       |        |        |       |        |       |
| 18         |                                         |       |        |        |       |        |       |
| 19         |                                         |       |        |        |       |        |       |
| 20         |                                         |       |        |        |       |        |       |
| 21         |                                         |       |        |        |       |        |       |
| 22         |                                         |       |        |        |       |        |       |
| 23         |                                         |       |        |        |       |        |       |
| 24         |                                         |       |        |        |       |        |       |
| 25         |                                         |       |        |        |       |        |       |
| 26         |                                         |       |        |        |       |        |       |
| 27         |                                         |       |        |        |       |        |       |
| 28         |                                         |       |        |        |       |        |       |
| 29         |                                         |       |        |        |       |        |       |
| 30         |                                         |       |        |        |       |        |       |
| 31         |                                         |       |        |        |       |        |       |
| 32         |                                         |       |        |        |       |        |       |
| 33         |                                         |       |        |        |       |        |       |
| 34         |                                         |       |        |        |       |        |       |
| 35         |                                         |       |        |        |       |        |       |
| 36         |                                         |       |        |        |       |        |       |
| 37         |                                         |       |        |        |       |        |       |
| 38         |                                         |       |        |        |       |        |       |
| 39         |                                         |       |        |        |       |        |       |
| 40         |                                         |       |        |        |       |        |       |

## Structured Cabling Outlets – Summary

[Installer to complete]

| Room  | Service |       |        |        |    |             |           |
|-------|---------|-------|--------|--------|----|-------------|-----------|
|       | Data    | Phone | FTA TV | Pay TV | IR | Dist. Music | 5.1 Audio |
|       |         |       |        |        |    |             |           |
|       |         |       |        |        |    |             |           |
|       |         |       |        |        |    |             |           |
|       |         |       |        |        |    |             |           |
|       |         |       |        |        |    |             |           |
|       |         |       |        |        |    |             |           |
|       |         |       |        |        |    |             |           |
|       |         |       |        |        |    |             |           |
|       |         |       |        |        |    |             |           |
|       |         |       |        |        |    |             |           |
| TOTAL |         |       |        |        |    |             |           |

### Notes

---



---



---



---



---

Note that with most standard residential telephone services you can only connect equipment (e.g. telephones) up to a maximum rating of REN 3 (5 for NZ) at any one time. Look on your telephone equipment to determine the REN rating and ensure that your home does not exceed a total of 3. If you require more phones try adding cordless phones or consider purchasing a Hills PABX for a Small Office/Home Office (SOHO).

## Warranty Statements

### Installer

[Installer/Installation Company to complete]

---

---

---

---

---

---

---

---

|                                                                                                                                                                                 |
|---------------------------------------------------------------------------------------------------------------------------------------------------------------------------------|
| <p>This Hills Home Hub was installed by:</p> <p>Company: _____</p> <p>Installer: _____</p> <p>Address: _____</p> <p>                  _____</p> <p>For service phone: _____</p> |
|---------------------------------------------------------------------------------------------------------------------------------------------------------------------------------|

### Manufacturer

Direct Alarm Supplies guarantees this product against defective parts and workmanship for twenty-four (24) months from date of purchase. If any defect appears during the warranty period return it to DAS, postage prepaid. The unit will be repaired and returned. DAS assumes no liability for consequential or indirect damage and accepts no responsibility for repairing damage to the product caused by misuse, careless handling, or where unauthorised repairs have been made.

No other guarantee, written or verbal, is authorized by or on behalf of Direct Alarm Supplies.

DIRECT ALARM SUPPLIES  
12 Wiggs Road Riverwood  
NSW 2210 AUSTRALIA  
PHONE (02) 97175222  
FAX (02) 97175221









**Contact Us**

**38 Shafton Street  
Huntingdale VIC 3166**

**03 9778 4333**

**[info@ryve.com.au](mailto:info@ryve.com.au)  
[www.ryve.com.au](http://www.ryve.com.au)**